

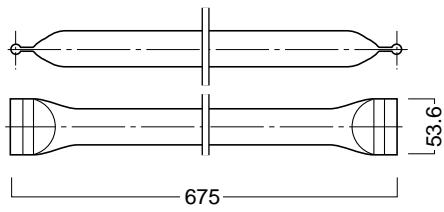

Struktur

Horizontal tube / OS 101



Size

Horizontal tube

- 470
- 675
- 965

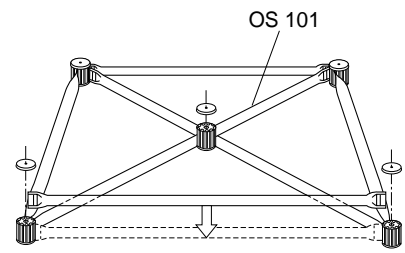

Horizontal tube / OS 102

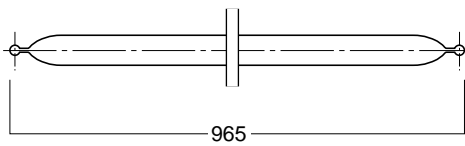

Diagonal tube

- 425
- 866

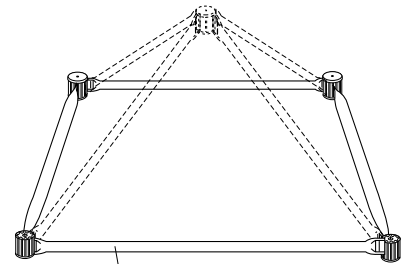

Diagonal tube / OS 103

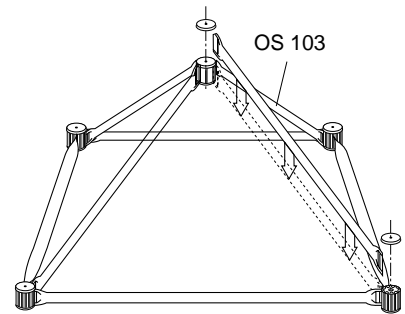
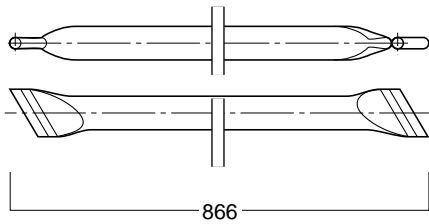

Horizontal tube / OS 112

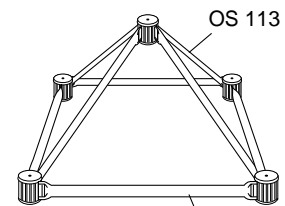
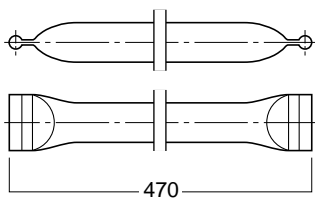

Diagonal tube / OS 113

